

21-001*-10GD*/***
 21-001*-10GG*/***
 21-001*-10GH*/***
 21-001*-10GI*/***
 21-001*-10GJ*/***

LED 1000 lm
 LED 2000 lm
 LED 3000 lm
 LED 4000 lm
 LED 5000 lm

21-001*-20GD*/***
 21-001*-20GG*/***
 21-001*-20GH*/***
 21-001*-20GI*/***
 21-001*-20GJ*/***

2x LED 1000 lm
 2x LED 2000 lm
 2x LED 3000 lm
 2x LED 4000 lm
 2x LED 5000 lm

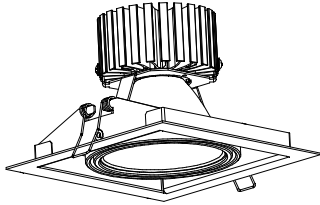

a x b = 165 x 165 mm

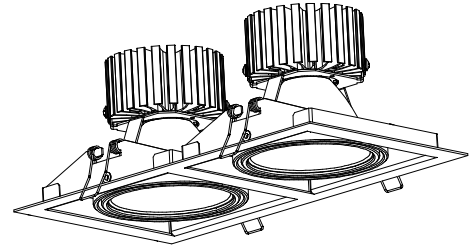

a x b = 165 x 330 mm

21-001*-30GD*/***
 21-001*-30GG*/***
 21-001*-30GH*/***
 21-001*-30GI*/***
 21-001*-30GJ*/***

3x LED 1000 lm
 3x LED 2000 lm
 3x LED 3000 lm
 3x LED 4000 lm
 3x LED 5000 lm

21-001*-40GD*/***
 21-001*-40GG*/***
 21-001*-40GH*/***
 21-001*-40GI*/***
 21-001*-40GJ*/***

4x LED 1000 lm
 4x LED 2000 lm
 4x LED 3000 lm
 4x LED 4000 lm
 4x LED 5000 lm

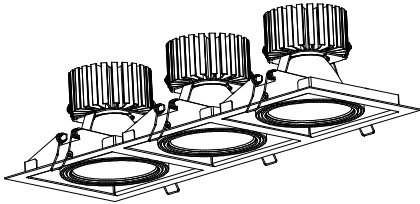

a x b = 165 x 495 mm

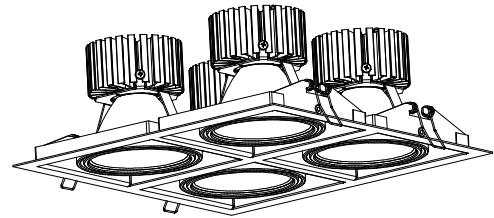

a x b = 333 x 333 mm

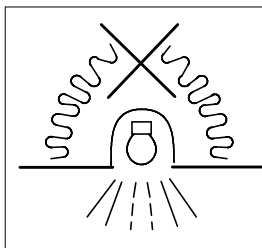
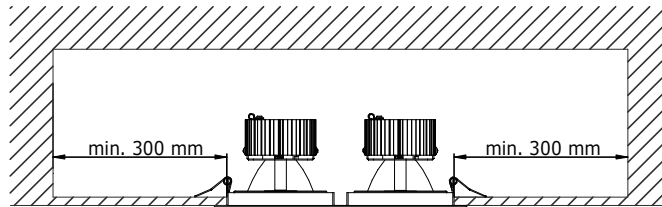
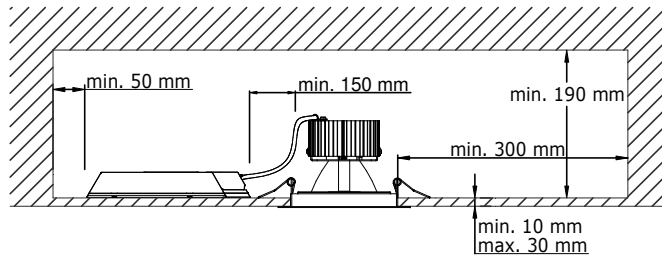

- Nepřekrývat svítidlo izolačním materiálem !
- Luminaire must not be covered with insulating material !
- Die Leuchte nicht mit Isoliermaterial überdecken !
- Не перекрывать светильник изоляционным материалом !

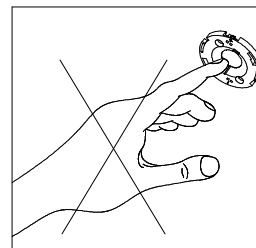

- NESAHAT NA LEDKU !
- DO NOT TOUCH LED !
- NICHT BERÜHREN LED !
- Не касаться LED !

1.

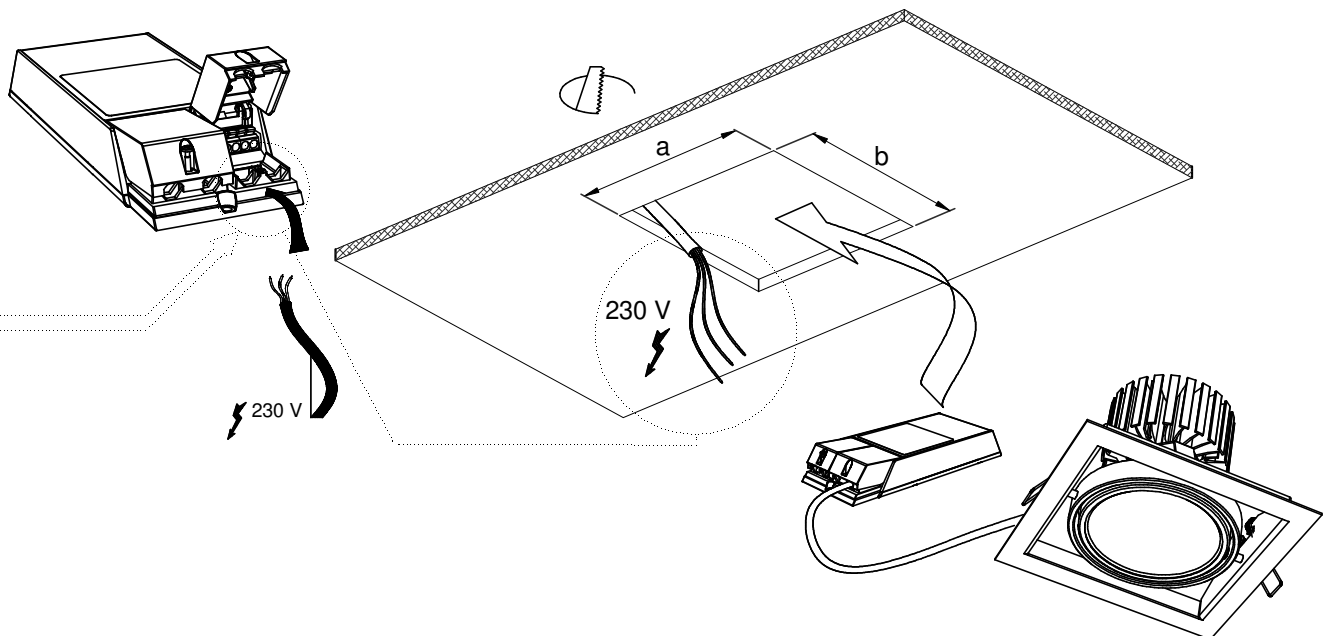

2.

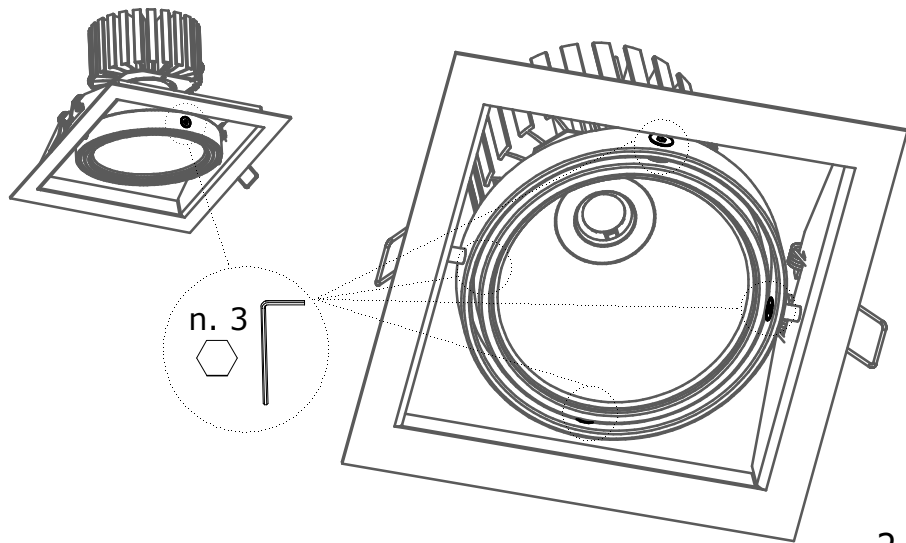
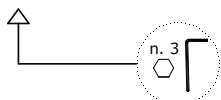
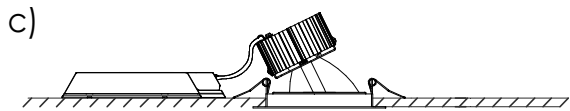
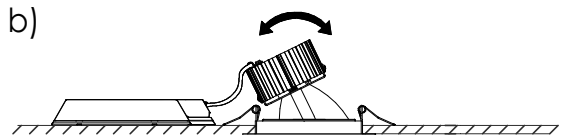
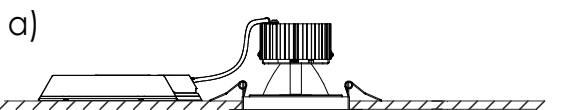
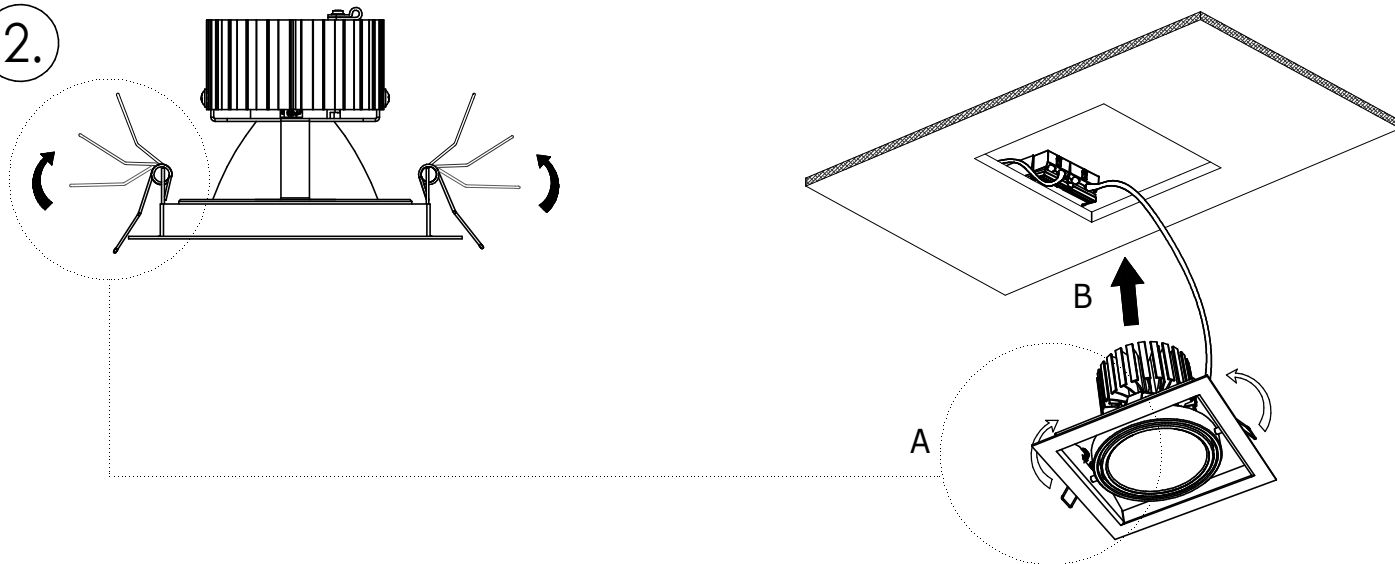

2.

- Montáž smí provádět pouze pracovník s odbornou elektrotechnickou kvalifikací. Před prováděním jakékoliv údržby vypněte přívod el. proudu.
- The installation may only be carried by authorised specialist. Always switch-off the power supply before carrying out any maintenance.
- Die Leuchtenmontage kann nur von autorisiertem Fachpersonal durchgeführt werden. Vor der beliebigen Wartungsausführung die Einspeisung abschalten.
- Установка светильников разрешена только квалифицированным электромонтером. Перед любым ремонтом или уходом за светильником необходимо выключить питание.

- Výrobce nenesie zodpovednosť za nesprávne zacházení s produkty.
- The manufacturer is not responsible for the incorrect use and assembly of its products.
- Der Hersteller trägt keine Verantwortung für eine falsche Verwendung des Produktes.
- Производитель не несет ответственности за неправильное обращение с продуктом.