

⚠

⚠

ⓐ L > 2000mm = 3x

ⓑ L > 2000mm = 2x

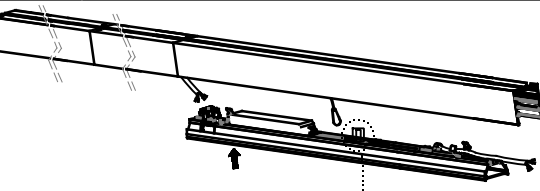
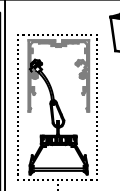
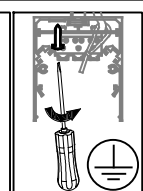
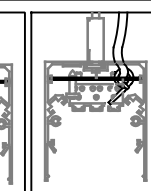
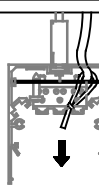
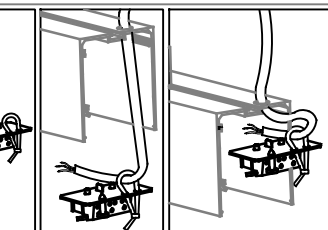
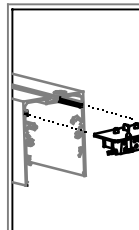
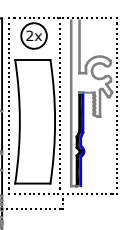
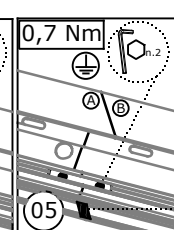
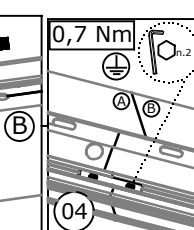
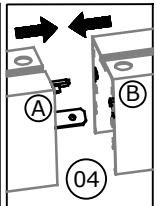
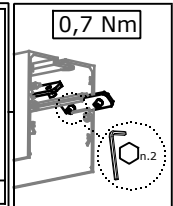
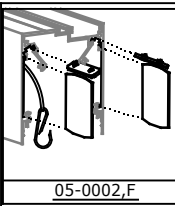
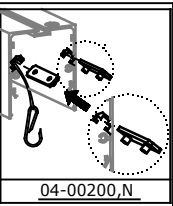
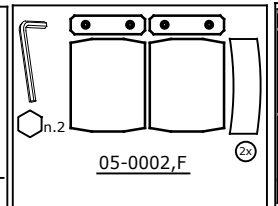
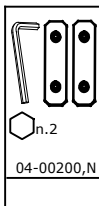

- Světelný zdroj v tomto svítidle smí vyměnit pouze výrobce nebo jeho smluvní servisní technik nebo podobně kvalifikovaná osoba!
- The light source in this luminaire may be replaced only by the manufacturer or its contractual service technician or a similarly qualified person!
- Die Lichtquelle dieser Leuchte darf nur vom Hersteller oder einem von ihm beauftragten Servicetechniker oder einer vergleichbar qualifizierten Person ersetzt werden.
- Источник света данного светильника может быть заменен только производителем, уполномоченным им сервисным техником или специалистом с соответствующей квалификацией
- Montáž smí provádět pouze pracovník s odbornou elektrotechnickou kvalifikací. Před prováděním jakékoliv údržby vypněte přívod el. proudu.
- The installation may only be carried by authorised specialist. Always switch-off the power supply before carrying out any maintenance.
- Die Leuchtenmontage kann nur von autorisiertem Fachpersonal durchgeführt werden. Vor der beliebigen Wartungsausführung die Einspeisung abschalten.
- Установка светильников разрешена только квалифицированным электромонтером. Перед любым ремонтом или уходом за светильником необходимо выключить питание.

- Výrobce nenesie zodpovednosť za nesprávne zacházení s produktom.
- The manufacturer is not responsible for the incorrect use and assembly of its products.
- Der Hersteller trägt keine Verantwortung für eine falsche Verwendung des Produktes.
- Производитель не несет ответственности за неправильное обращение с продуктом.



Lipo60 , Lipo80

- Montážní návod
- Installation instruction
- Montageanleitung
- План сборки светильника

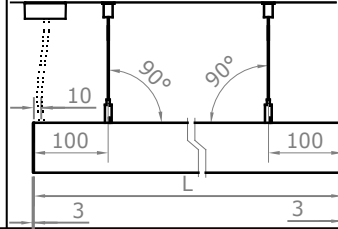
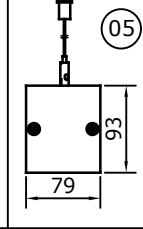
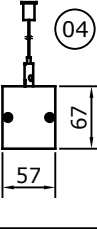
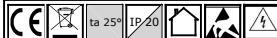

04/05-20001*	L = 561mm	04/05-A00*-10G*
04/05-20002*	L = 842mm	04/05-A00*-15G*
04/05-20003*	L = 1122mm	04/05-A00*-20G*
04/05-20004*	L = 1403mm	04/05-A00*-25G*
04/05-20005*	L = 1683mm	04/05-A00*-30G*
04/05-20006*	L = 1964mm	04/05-A00*-35G*
04/05-20007*	L = 2244mm	04/05-A00*-40G*
04/05-20008*	L = 3366mm	
04/05-20009*	L = 4488mm	

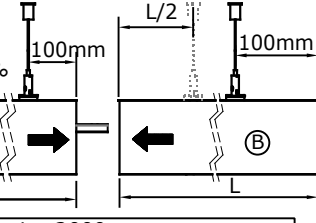
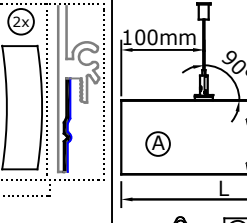
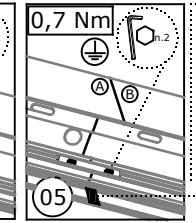
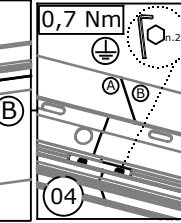
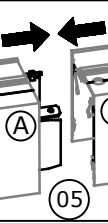
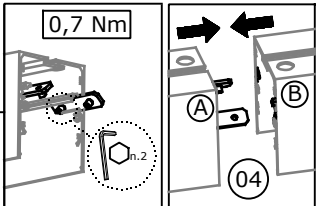
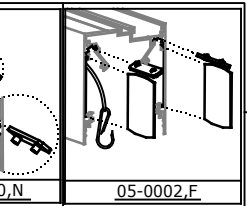
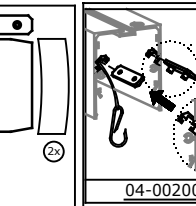
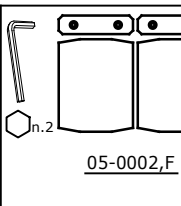
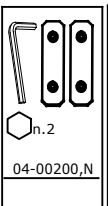
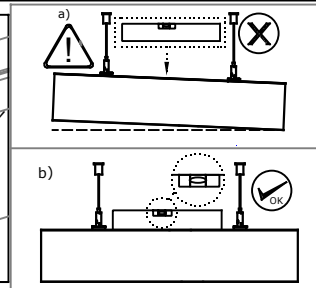
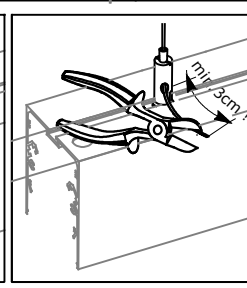
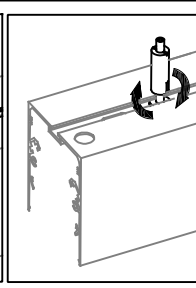
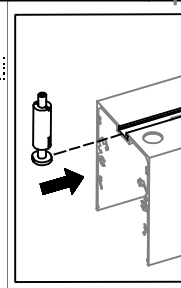
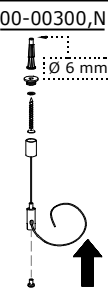

⚠

ⓐ L > 2000mm = 3x 00-00300,N

ⓑ L > 2000mm = 2x 00-00300,N

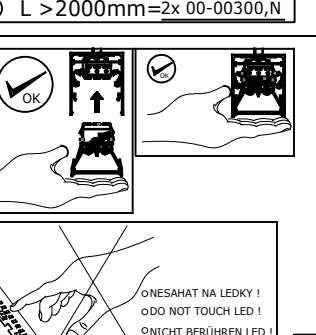
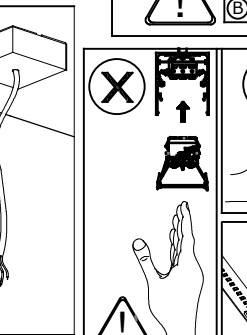
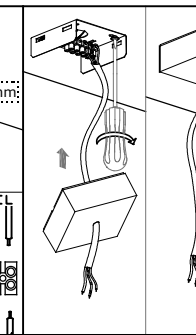
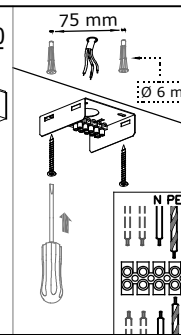
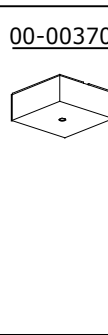

- NESAHAT NA LEDKY !
- DO NOT TOUCH LED !
- NICHT BERÜHREN LED !
- Не касаться LED !

00-00500 - 20Gxx
00-00501 - 40Gxx

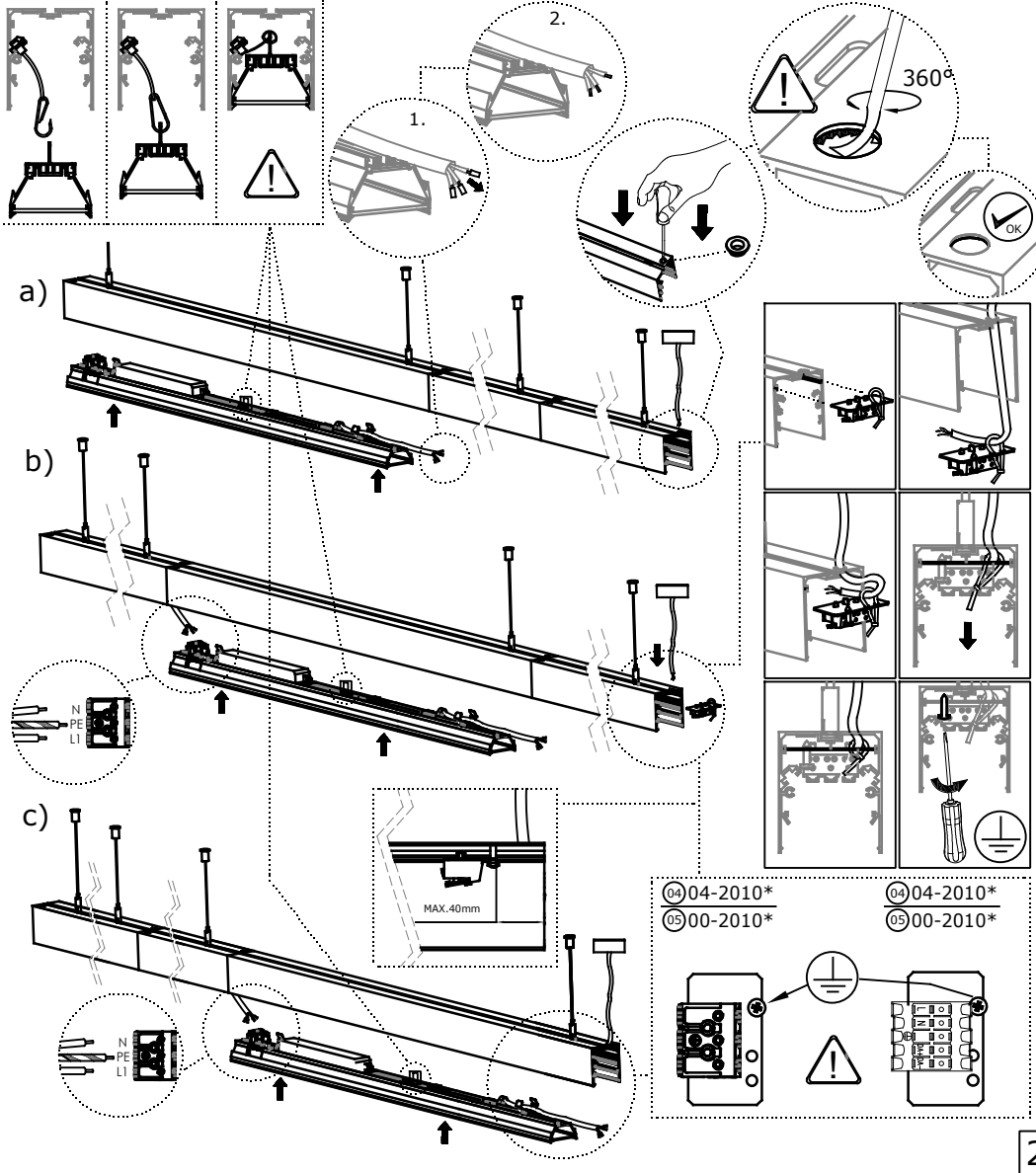
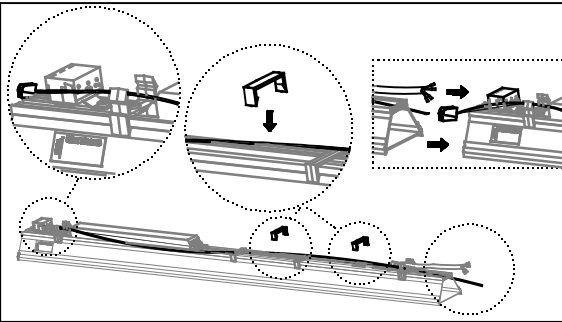
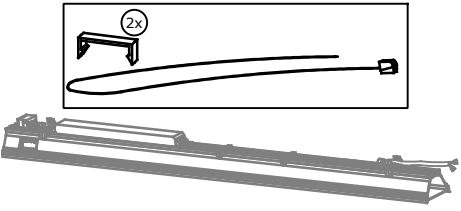

04 04-20100 05 00-20100
04 04-20101 05 00-20101

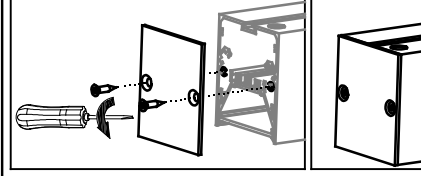

04 04-20102 05 00-20102
04 04-20103 05 00-20103

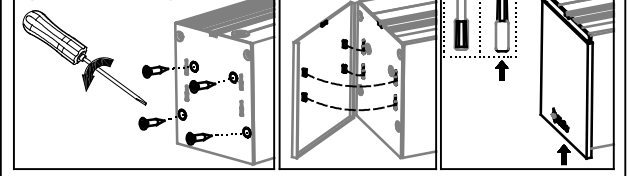

04 04-20900,F
05 00-20900,F

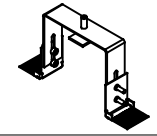

○ Nepřekrývat svítidlo izolačním materiálem !
○ Luminaire must not be covered with insulating material !
○ Die Leuchte nicht mit Isoliermaterial überdecken !
○ Не перекрывать светильник изоляционным материалом !

